



EPR, EKS Serileri Fiş ve Prizler

- Kademeli kablo girişi
- Estetik tasarım
- Grup prizlerde tek parça kontak yapısı ve ayrılmış bağlantı

Teknik Bilgiler

Kontakt Sayısı	2P+E	3P+E
Mekanik Ömür	: ≥ 5.000	≥ 5.000
Elektriksel Ömür	: ≥ 1.000	≥ 1.000
Çalışma Sıcaklığı	: $-25 / +125^{\circ}$	$-25 / +125^{\circ}$
Koruma Sınıfı	: IP44 (Birleştirilmiş Fiş-Priz)	IP44 (Birleştirilmiş Fiş-Priz)
Çalışma Gerilimi (Ue)	: 250V	440V
Çalışma Akımı (Ie)	: 16 A	25 A
Yalıtım Gerilimi (Ui)	: 500V	500V
Darbe Dayanım Gerilimi (Uimp)	: 2 kV	2 kV
Çalışma Frekansı (f)	: 50-60 Hz	50-60 Hz
İzolasyon Direnci	: 10 M Ω min. (500V DC)	
Kullanım Sınıfı	: AC15	
Dielektrik Mukavemeti	: 2.000V AC	2.000V AC
Bağlantı Kablo Kesiti	: 1.5 mm ²	2.5 mm ²
Standart	: TS IEC 60884-1+A1+A2	

EPR, EKS Series Plugs & Sockets

- Graded cable entry
- Aesthetic design
- Monoblock contact structure and seperated connection in group sockets

Technical Information

	2P+E	3P+E
Mechanical Life	: ≥ 5.000	≥ 5.000
Electrical Life	: ≥ 1.000	≥ 1.000
Operating Temperature	: $-25 / +125^{\circ}$	$-25 / +125^{\circ}$
Protection Degree	: IP44 (Jointed Plug-Socket)	IP44 (Jointed Plug-Socket)
Operating Voltage (Ue)	: 250V	440V
Operating Current (Ie)	: 16 A	25 A
Insulation Voltage (Ui)	: 500V	500V
Impact Resistance (Uimp)	: 2 kV	2 kV
Operating Frequency (f)	: 50-60 Hz	50-60 Hz
Insulation Resistance	: 10 M Ω min. (500V DC)	
Utilization Category	: AC15	
Dielectric Strength	: 2.000V AC	2.000V AC
Cable Section	: 1.5 mm ²	2.5 mm ²
Standard	: TS IEC 60884-1+A1+A2	

Endüstriyel Fiş ve Prizler Industrial Plugs & Sockets



Pano Tipi Priz / Panel Type Sockets

Ürün Kodu Code	Özellik Features	Renk Colour
EPREU1M	Pano Prizi, Avrupa Schuko Tip 1 / European Schuko Type 1	●
EPRUS1H	Amerikan, Tip1 / American, Type1	●
EPREU2G	Ray Tipi / Rail Types	●
EPREU2GL	Ray Tipi, Ledli / Rail Types, with LED	●



EPREU1M



EPRUS1H



EPREU2G



EPREU2GL

Kauçuk Serisi Fiş Priz / Rubber Type Plugs & Sockets

Ürün Kodu Code	Tip Type	Özellik Features
EKS116F	Düz Fiş / Plug	1 x 16 A
EKS116P	Uzatma Priz / Socket	1 x 16 A
EKS116PG1	Duvar Prizi / Wall Socket	1 x 16 A
EKS116PG3	Grup Priz Üçlü / Group Socket - 3 Way	3x (1 x 16 A)
EKS325F	Düz Fiş / Plug	3 x 25 A
EKS325P	Uzatma Priz / Socket	3 x 25 A
EKS325PGP30	Grup Priz Üçlü / Group Socket - 3 Way	3 x (3 x 25) A
EKS325PG21	Grup Priz Üçlü / Group Socket - 3 Way	2 x (3x25) A + 1 (1x16) A
EKS325PG12	Grup Priz Üçlü / Group Socket - 3 Way	1 x (3x25) A + 2 (1x16) A



EKS116P



EKS116PG3



EKS325F



EKS116F



EKS116PG1

Endüstriyel Fiş ve Prizler Industrial Plugs & Sockets

EMES®

BOYUTLAR (mm) / DIMENSIONS (mm)

EKS Serisi Kauçuk Seris Fiş ve Priz / EKS Series Rubber Plugs & Sockets

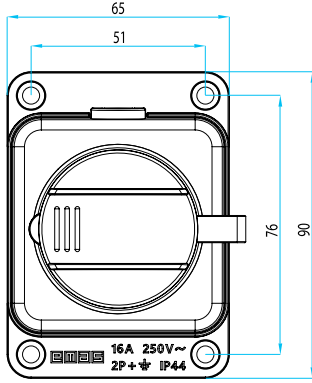

16x1 Duvar Prizi
16x1 Housing Female Insert
(Surface Mounting)

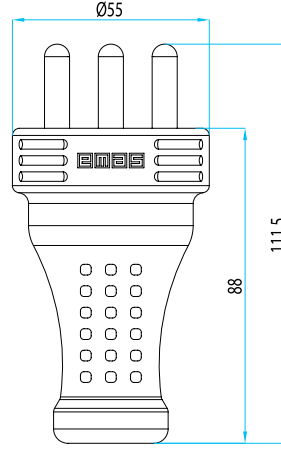
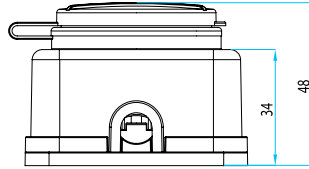

25x3 Uzatma Fiş
25x3 Hood with male insert

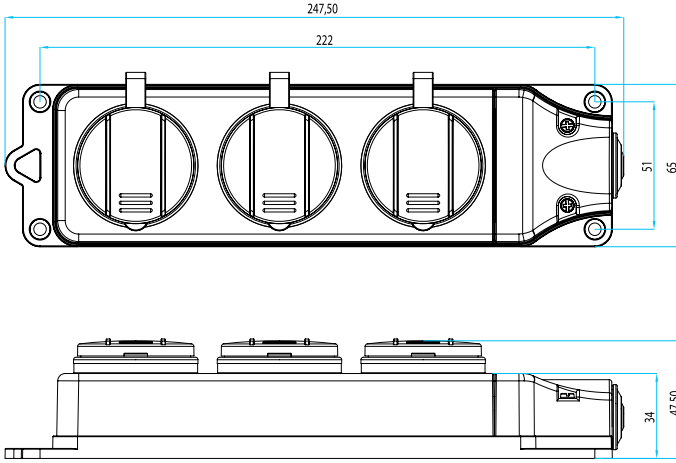
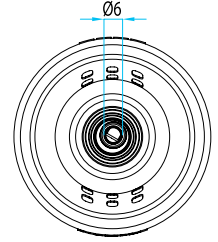

16x3 Grup Priz
16x3 Group Socket

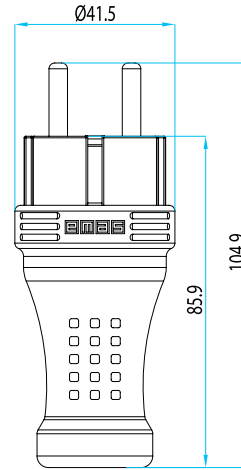

16x1 Uzatma Fiş
16x1 Hood with male insert

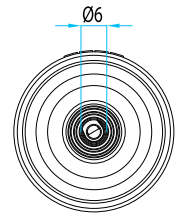

EPR Serisi Kauçuk Seris Fiş ve Priz / EPR Series Rubber Plugs & Sockets

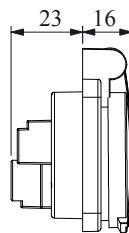
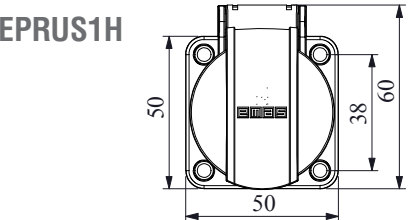
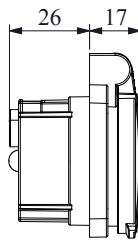
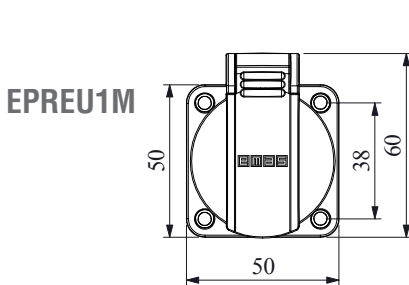

EPREU2G

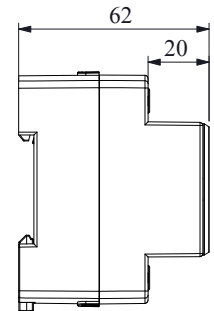
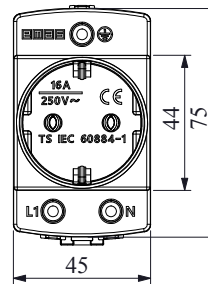

Endüstriyel Fiş ve Prizler

Industrial Plugs & Sockets



EBP05FU30	EBP05PU30	EBP05PU36	EBP05PE41	EBA05TK	EBM05FU30	EBM05PU30
EBM05PU36	EBM05PE41	EBM06FU30	EBM06FM42	EBM06PU32	EBM06PU30	EBA06TK
EBM10PU10	EBM10PU30	EBM10FD24	EBM10PM44	EBM10PM47	EBM10PD27	EBA10TK
EB016CF00	EB016CP00	EBM16FU10	EBM16FM44	EBM16PD14	EBM16FD24	EBA24TK
EBA16TK	EB024CP00	EB024CF00	EBM24FU10	EBM24PU10	EBM24FD24	EBM24PM44
EBM32FU10	EBM32PU10	EBM32PM44	EBM32FM44	EBA48TK	EBA32TK	EBM48PU10
EBM48FU10	EBM48FU30	EBM48PM44	EB0606CP00	EB0606CF00	EBM606FU10	EBM606PD14
EBM612PU10	EBM612PM44	EB0806CF00	EB0806CP00	EBM806FU10	EBM806PD14	EBM812FU30
EBM812PM44	EBMKE	EBMKD				